

ISOLATED DC/DC CONVERTER CFDHR300-110 SERIES



Beijing Huayang Changfeng Technology Co., Ltd
Huayang Changfeng Hebei Technology Co., Ltd

Address of China factory: No. 25, Torch South Street, development zone,
Zhuozhou City, Baoding City, Hebei Province, China

WWW.CHEWINS.NET



Contents

1. Introduction	3
2. DC-DC Converter Features.....	3
3. Electrical Block Diagram	3
4. Technical Specifications.....	4
5. Main Features and Functions.....	8
5.1 Operating Temperature Range	8
5.2 Output Voltage Adjustment	8
5.3 Over Current Protection	8
5.4 Output Over Voltage Protection	8
5.5 Remote On/Off	8
5.6 UVLO (Under Voltage Lock Out)	8
5.7 Over Temperature Protection.....	9
6. Applications.....	9
6.1 Recommend Layout, PCB Footprint and Soldering Information.....	9
6.2 Connection for standard use	9
6.3 Input Capacitance at the Power Module	10
6.4 Convection Requirements for Cooling	10
6.5 Thermal Considerations.....	10
6.6 Power Derating	11
6.7 Half Brick Heat Sinks:	13
6.8 Efficiency VS. Load	14
6.9 Test Set-Up	15
6.10 Output Voltage Adjustment	15
6.11 Output Remote Sensing.....	16
6.12 Output Ripple and Noise	17
6.13 Output Capacitance	17
6.14 Remote On/Off circuit.....	17
6.15 Series operation	18
6.16 Parallel / Redundant operation	18
6.17 Hold up Time.....	18
7. Safety & EMC.....	19
7.1 Input Fusing and Safety Considerations	19
7.2 EMC Considerations	19
7.3 Suggested Configuration for RIA12 Surge Test.....	25
8. Part Number.....	26
9. Mechanical Specifications	26
9.1 Mechanical Outline Diagrams	26

MODEL NUMBER	INPUT VOLTAGE	OUTPUT VOLTAGE	OUTPUT CURRENT		INPUT CURRENT		% EFF. (2)	CAPACITOR LOAD MAX.
			MIN.	MAX.	NO LOAD	FULL LOAD		
CFDHR300-110S03	43-160V _{DC}	3.3V _{DC}	0mA	60A	10mA	2093mA	86	60000uF
CFDHR300-110S05		5V _{DC}		60A		3099mA	88	60000uF
CFDHR300-110S12		12V _{DC}		25A		3030mA	90	25000uF
CFDHR300-110S24		24V _{DC}		12.5A		3064mA	89	12500uF
CFDHR300-110S28		28V _{DC}		10.7A		3064mA	89	10700uF
CFDHR300-110S48		48V _{DC}		6.25A		2997mA	91	4700uF

NOTE:

1. Nominal Input Voltage 110 V_{DC}.
2. Measure at Nominal Input Voltage.

1. Introduction

The CFDHR300-110S series of DC-DC converters offers 300 watts of output power @ single output voltages of 3.3,5,12,24,28,48V_{DC} with industry standard half-brick. It has a wide (4:1) input voltage range of 43 to 160V_{DC}(110V_{DC} nominal) and 3000V_{DC} basic isolation.

Compliant with EN50155,EN45545,EN50121-3-2. High efficiency up to 91%, allowing case operating temperature range of -40°C to 100°C. An optional heat sink is available to extend the full power range of the unit. Very low no load power consumption (10mA), an ideal solution for energy critical systems.

The standard control functions include remote on/off (positive or negative) and +10%,-10% adjustable output voltage.

Fully protected against input UVLO (under voltage lock out), output over-current,output over-voltage and over-temperature and continuous short circuit conditions.

CFDHR300-110S series is designed primarily for common railway applications of 72V,96V,110V nominal voltage and also suitable for distributed power architectures,telecommunications,battery operated equipment and industrial applications.

2. DC-DC Converter Features

- ◆ 198-300W Isolated Output
- ◆ Efficiency to 91%
- ◆ Low No Load Power Consumption
- ◆ Fixed Switching Frequency
- ◆ 4:1 Input Range
- ◆ Regulated Outputs
- ◆ Input Under-Voltage Protection
- ◆ Over Temperature Protection
- ◆ Over Voltage/Current Protection
- ◆ Remote On/Off
- ◆ Half Brick Size meet industrial standard
- ◆ UL60950-1 2nd (Basic Insulation) Approval (Except 3.3Vout)
- ◆ CB Test Certificate IEC60950-1 (Except 3.3Vout)
- ◆ Meet EN50155 With External Circuits
- ◆ Shock/Vibration Meet EN 50155 (EN 61373)
- ◆ Fire & Smoke meet EN45545-2
- ◆ 5000m Operating Altitude

3. Electrical Block Diagram

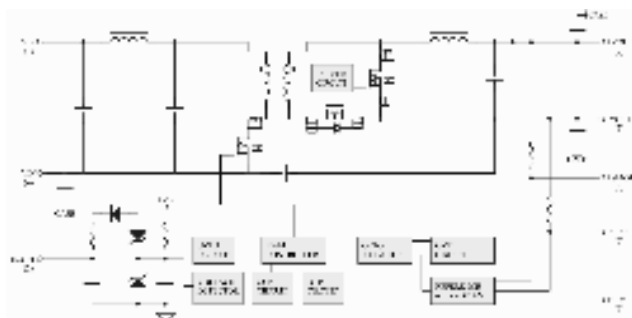

Electrical Block Diagram for 3.3Vout, 5Vout and 12Vout

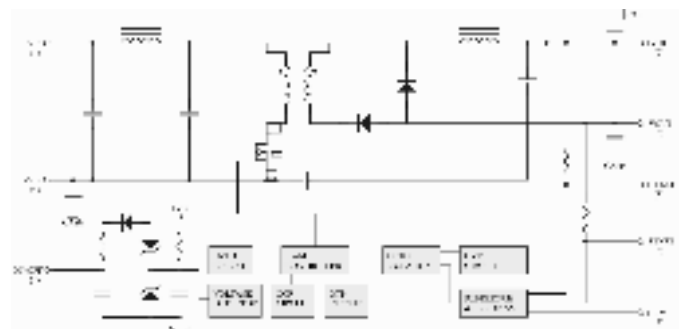

Electrical Block Diagram for other modules

4. Technical Specifications

(All specifications are typical at nominal input, full load at 25°C unless otherwise noted.)

ABSOLUTE MAXIMUM RATINGS

PARAMETER	NOTES and CONDITIONS	Device	Min.	Typ.	Max.	Units
Input Voltage						
Continuous		All	-0.3		160	V _{DC}
Transient	100ms	All			200	V _{DC}
Operating Case Temperature		All	-40		100	°C
Storage Temperature		All	-55		125	°C
Isolation Voltage	1 minute; input/output, input/case	All			3000	V _{DC}
	1 minute; output/case	All			500	V _{DC}

INPUT CHARACTERISTICS

PARAMETER	NOTES and CONDITIONS	Device	Min.	Typ.	Max.	Units
Operating Input Voltage		All	43	110	160	V _{DC}
Input Under Voltage Lockout						
Turn-On Voltage Threshold		All	40	42	43	V _{DC}
Turn-Off Voltage Threshold		All	37	39	40	V _{DC}
Lockout Hysteresis Voltage		All		3		V _{DC}
Maximum Input Current	100% Load, V _{in} =43V _{DC}	Vo=3.3V		5500		mA
		Others		8000		mA
No-Load Input Current		All		10		mA
Input Filter	Pi filter.	All				
Inrush Current (I ² t)	As per ETS300 132-2.	All			0.1	A ² s
Input Reflected Ripple Current	P-P thru 12uH inductor, 5Hz to 20MHz, See 6.5	All		40		mA

OUTPUT CHARACTERISTICS

PARAMETER	NOTES and CONDITIONS	Device	Min.	Typ.	Max.	Units
Output Voltage Set Point	V _{in} =Nominal V _{in} , I _o = I _{o_max} , T _c =25°C	Vo=3.3V	3.267	3.3	3.333	V _{DC}
		Vo=5.0V	4.95	5	5.05	
		Vo=12V	11.88	12	12.12	
		Vo=24V	23.76	24	24.24	
		Vo=28V	27.72	28	28.28	
		Vo=48V	47.52	48	48.48	
Output Voltage Regulation						
Load Regulation	I _o =I _{o_min} to I _{o_max}	All			±0.2	%
Line Regulation	V _{in} =low line to high line	All			±0.2	%
Temperature Coefficient	T _c =-40°C to 100°C	All			±0.02	%/°C

PARAMETER	NOTES and CONDITIONS	Device	Min.	Typ.	Max.	Units
Output Voltage Ripple and Noise (5Hz to 20MHz bandwidth)						
Peak-to-Peak	Full load, 3.3V/5V:47uF T521KO CAP. <55mR and 1uF ceramic capacitor. Other:10uF aluminum solid and 1uF ceramic capacitor. See 6.12	Vo=3.3V			120	mV
		Vo=5.0V			120	
		Vo=12V			150	
		Vo=24V			240	
		Vo=28V			280	
		Vo=48V			480	
RMS.		Vo=3.3V			60	mV
		Vo=5.0V			60	
		Vo=12V			80	
		Vo=24V			120	
		Vo=28V			140	
		Vo=48V			220	
Operating Output Current Range		Vo=3.3V	0		60	A
		Vo=5.0V	0		60	
		Vo=12V	0		25	
		Vo=24V	0		12.5	
		Vo=28V	0		10.7	
		Vo=48V	0		6.25	
Output DC Current Limit Inception	Hiccup Mode. Auto Recovery. See 5.3	All	110	125	160	%
Maximum Output Capacitance	Full load (resistive)	Vo=3.3V	0		60000	uF
		Vo=5.0V	0		60000	
		Vo=12V	0		25000	
		Vo=24V	0		12500	
		Vo=28V	0		10700	
		Vo=48V	0		4700	
Output Voltage Trim Range	$P_{out} = \text{max rated power}$, See 6.10	All	-10		+10	%
Output Over Voltage Protection	Limited Voltage, See 5.4	All	115	125	140	%

DYNAMIC CHARACTERISTICS

PARAMETER	NOTES and CONDITIONS	Device	Min.	Typ.	Max.	Units
Output Voltage Current Transient						
Error Band	75% to 100% of I_{o_max} step load change $d_i/d_t=0.1A/us$ (within 1% V_{out} nominal)	All			±5	%
Recovery Time		All			250	us
Turn-On Delay and Rise Time	Full load (Constant resistive load)					
Turn-On Delay Time, From On/Off Control	$V_{on/off}$ to $10\%V_{o_set}$	All		20		ms
Turn-On Delay Time, From Input	V_{in_min} to $10\%V_{o_set}$	All		20		ms
Output Voltage Rise Time	$10\%V_{o_set}$ to $90\%V_{o_set}$	All		15		ms

EFFICIENCY

PARAMETER	NOTES and CONDITIONS	Device	Min.	Typ.	Max.	Units
100% Load	Vin=110V See 6.8	Vo=3.3V		86		%
		Vo=5.0V		88		
		Vo=12V		90		
		Vo=24V		89		
		Vo=28V		89		
		Vo=48V		91		

ISOLATION CHARACTERISTICS

PARAMETER	NOTES and CONDITIONS	Device	Min.	Typ.	Max.	Units
Isolation Voltage	1 minute;input/output	All			3000	V _{DC}
	1 minute;input/case,				3000	
	1 minute; output/case				500	V _{AC}
Isolation Resistance	Input/Output	All	100			MΩ
Isolation Capacitance	Input/Output	All		3000		pF
	Input/Case			3000		
	Output/Case			20000		

FEATURE CHARACTERISTICS

PARAMETER	NOTES and CONDITIONS	Device	Min.	Typ.	Max.	Units
Switching Frequency	Pulse wide modulation (PWM),Fixed	Vo=3.3V	225	250	275	KHz
		Others	270	300	330	
On/Off Control, Positive Remote On/Off logic, Refer to -Vin pin.						
Logic Low (Module Off)	V _{on/off} at I _{on/off} =1.0mA	All	0		1.2	V
Logic High (Module On)	V _{on/off} at I _{on/off} =0.0uA	All	3.5 or Open Circuit		160	V
On/Off Control, Negative Remote On/Off logic, Refer to -Vin pin						
Logic High (Module Off)	V _{on/off} at I _{on/off} =0.0uA	All	3.5 or Open Circuit		160	V
Logic Low (Module On)	V _{on/off} at I _{on/off} =1.0mA	All	0		1.2	V
On/Off Current (for both remote on/off logic)	I _{on/off} at V _{on/off} =0.0V	All		0.3	1	mA
Leakage Current (for both remote on/off logic)	Logic High, V _{on/off} =15V	All			30	uA
Off Converter Input Current	Shutdown input idle current	All		3	5	mA
Over Temperature Shutdown	Aluminum baseplate temperature	All		110		°C
Over Temperature Recovery		All		100		°C

GENERAL SPECIFICATIONS

PARAMETER	NOTES and CONDITIONS	Device	Min.	Typ.	Max.	Units
MTBF	$I_o=100\%$ of I_{o_max} ; MIL - HDBK - 217F_Notice 1, GB, 25°C	Vo=48V Others		900 600		K hours
Weight		All		114		grams
Case Material	Plastic, DAP					
Baseplate Material	Aluminum					
Potting Material	UL 94V-0					
Pin Material	Base: Copper Plating: Nickel with Matte Tin					
Shock/Vibration	MIL-STD-810F / EN61373					
Humidity	95% RH max. Non Condensing					
Altitude	5000m Operating Altitude, 12000m Transport Altitude					
Thermal Shock	MIL-STD-810F					
Fire & Smoke	Meets EN45545-2					
EMI	Meets EN50155(EN50121-3-2) with external input filter, see 7.2					
ESD	EN61000-4-2	Level 3: Air $\pm 8kV$, Contact $\pm 6kV$				Perf.Criteria A
Radiated immunity	EN61000-4-3	Level 3: 80~1000MHz, 20V/m				Perf.Criteria A
Fast Transient	EN61000-4-4	Level 3: On power input port, $\pm 2kV$, external input capacitor required, see 7.1				Perf.Criteria A
Surge	EN61000-4-5	Level 4: Line to earth, $\pm 4kV$, Line to line, $\pm 2kV$				Perf.Criteria A
Conducted immunity	EN61000-4-6	Level 3: 0.15~80MHz, 10V				Perf.Criteria A
Interruptions of Voltage Supply	EN50155	Class S2: 10ms Interruptions, see 6.17				Perf.Criteria B
Supply Change Over	EN50155	Class C2: During a supply break of 30 ms				Perf.Criteria B

5. Main Features and Functions

5.1 Operating Temperature Range

The CFDHR300-110S series converters can be operated within a wide case temperature range of -40°C to 100°C. Consideration must be given to the derating curves when ascertaining maximum power that can be drawn from the converter. The maximum power drawn from open half brick models is influenced by usual factors, such as:

- Input voltage range
- Output load current
- Forced air or natural convection
- Heat sink optional

5.2 Output Voltage Adjustment

Section 6.10 describes in detail how to trim the output voltage with respect to its set point. The output voltage on all models is adjustable within the range of +10% to -10%.

5.3 Over Current Protection

All models have internal over current and continuous short circuit protection. The unit operates normally once the fault condition is removed. At the point of current limit inception, the converter will go into hiccup mode protection.

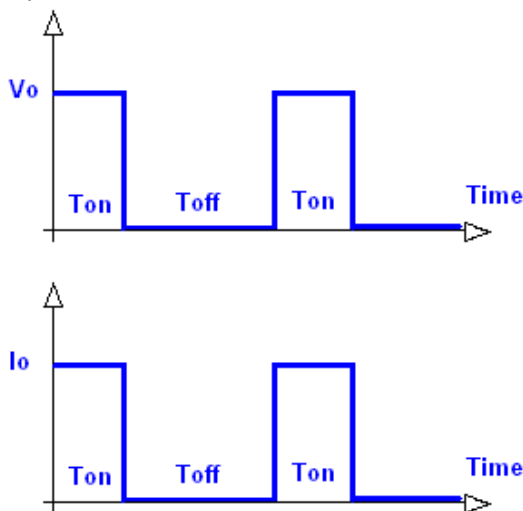

5.4 Output Over Voltage Protection

The output over voltage protection consists of circuitry that internally limits the output voltage. If more accurate output over voltage protection is required then an external circuit can be used via the remote on/off pin.

Note: Please note that device inside the power supply might fail when voltage more than rate output voltage is applied to output pin. This could happen when the customer tests the over voltage protection of unit.

5.5 Remote On/Off

The CFDHR300-110S series allows the user to switch the module on and off electronically with the remote on/off feature. All models are available in “positive logic” and “negative logic” (optional) versions. The converter turns on if the remote On/Off pin is high (>3.5Vdc to 160Vdc or open circuit). Setting the pin low (0 to <1.2Vdc) will turn the converter off. The signal level of the remote On/Off input is defined with respect to ground. If not using the remote on/off pin, leave the pin open (converter will be on). Models with part number suffix “N” are the “negative logic” remote On/Off version. The unit turns off if the remote On/Off pin is high (>3.5Vdc to 160Vdc or open circuit). The converter turns on if the On/Off pin input is low (0 to <1.2Vdc). Note that the converter is off by default. See 6.14

Logic State (Pin 2)	Negative Logic	Positive Logic
Logic Low – Switch Closed	Module on	Module off
Logic High – Switch Open	Module off	Module on

5.6 UVLO (Under Voltage Lock Out)

Input under voltage lockout is standard on the CFDHR300-110S unit. The unit will shut down when the input voltage drops below a threshold, and the unit will operate when the input voltage goes above the upper threshold.

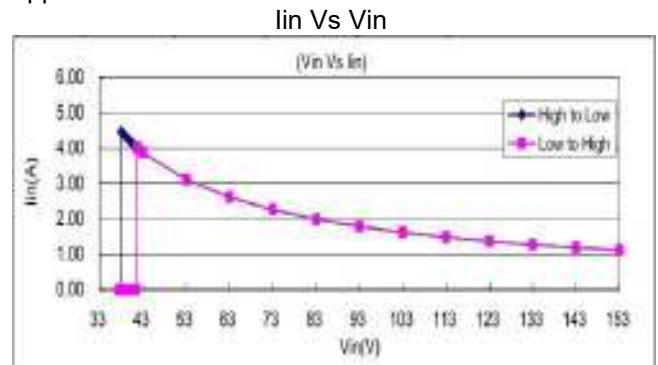

5.7 Over Temperature Protection

These modules have an over temperature protection circuit to safeguard against thermal damage. Shutdown occurs with the maximum case reference temperature is exceeded. The module will restart when the case temperature falls below over temperature recovery threshold. Please measure case temperature of the center part of aluminum baseplate.

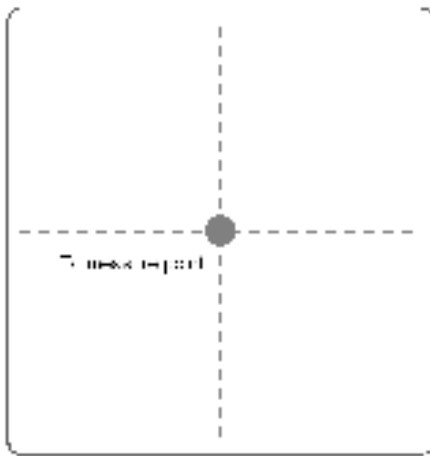
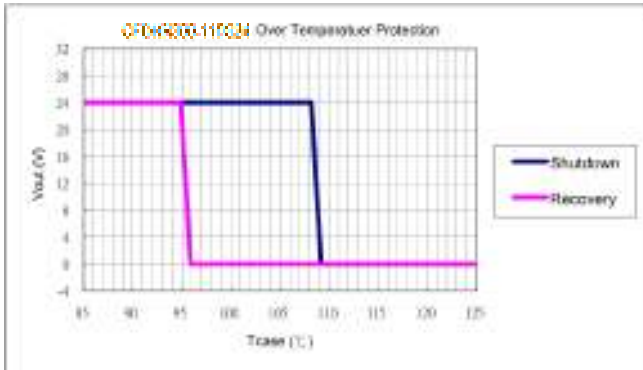

The suggested soldering iron is 450°C for up to 5seconds(less than 50W).Furthermore,the recommended soldering profile and PCB layout are shown below.

Lead Free Wave Soldering Profile

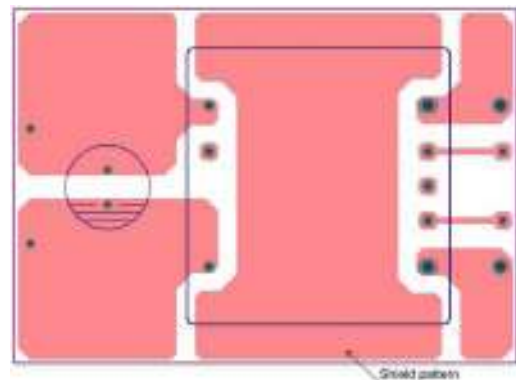
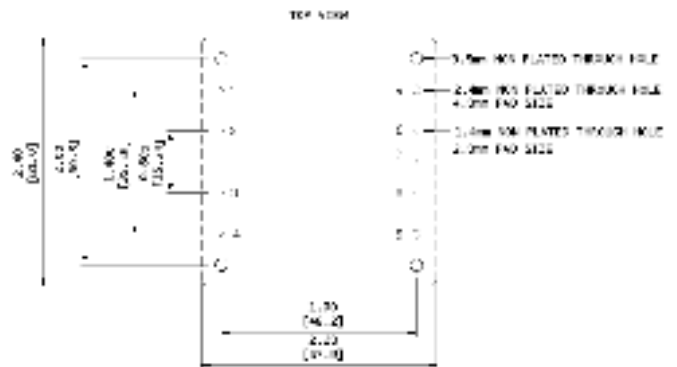
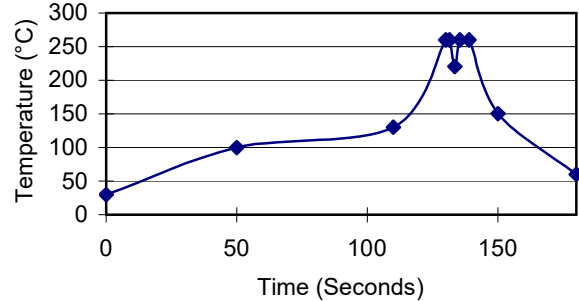

6. Applications

6.1 Recommend Layout, PCB Footprint and Soldering Information

The system designer or end user must ensure that metal and other components in the vicinity of the converter meet the spacing requirements for which the system is approved. Low resistance and inductance PCB layout traces are the norm and should be used where possible. Due consideration must also be given to proper low impedance tracks between power module, input and output grounds.

Clean the soldered side of the module with a brush, prevent liquid from getting into the module. Do not clean by soaking the module into liquid. Do not allow solvent to come in contact with product labels or resin case as this may changed the color of the resin case or cause deletion of the letters printed on the product label. After cleaning, dry the modules well.

6.2 Connection for standard use

The connection for standard use is shown below. An external input capacitor (C1) 220uF for all models is recommended to reduce input ripple voltage. External output capacitors (C2,C3) are recommended to reduce output ripple and noise, 3.3/5Vout with 47uF T521 KO CAP.<55mR and 1uF ceramic capacitor, other modes with 10uF aluminum solid and 1uF ceramic capacitor.

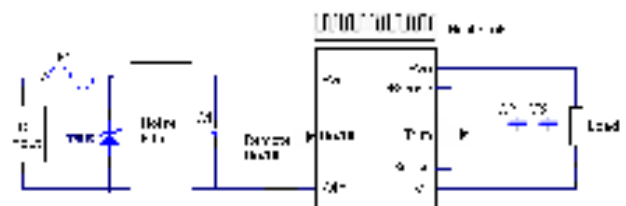

Symbol	Component	Reference
F1,TVS	Input fuse,TVS	Section 7.1
C1	External capacitor on input side	Note
C2,C3	External capacitor on the output side	Section 6.12/6.13
Noise Filter	External input noise filter	Section 7.2
Remote On/Off	External Remote On/Off control	Section 6.16
Trim	External output voltage adjustment	Section 6.10
Heat sink	External heat sink	Section 6.4/6.5/6.6/6.7
+Sense/-Sense	--	Section 6.11

Note:

If the impedance of input line is high, C1 capacitance must be more than above. Use more than two recommended capacitor above in parallel when ambient temperature becomes lower than -20 °C.

6.3 Input Capacitance at the Power Module

The converters must be connected to low AC source impedance. To avoid problems with loop stability source inductance should be low. Also, the input capacitors (Cin) should be placed close to the converter input pins to decouple distribution inductance. However, the external input capacitors are chosen for suitable ripple handling capability. Low ESR capacitors are good choice. Circuit as shown below represents typical measurement methods for reflected ripple current. C1 and L1 simulate a typical DC source impedance. The input reflected-ripple current is measured by current probe to oscilloscope with a simulated source inductance (L1).

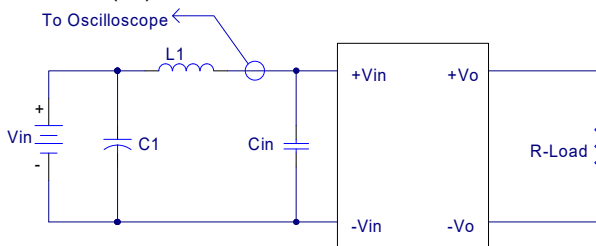

L1: 12uH

C1: 220uF ESR<0.14ohm @100KHz

Cin: 220uF ESR<0.14ohm @100KHz

6.4 Convection Requirements for Cooling

To predict the approximate cooling needed for the half brick module, refer to the power derating curves in section 6.6. These derating curves are approximations of the ambient temperatures and airflows required to keep the power module temperature below its maximum rating. Once the module is assembled in the actual system, the module's temperature should be monitored to ensure it does not exceed 100°C as measured at the center of the top of the case (thus verifying proper cooling).

6.5 Thermal Considerations

The power module operates in a variety of thermal environments; however, sufficient cooling should be provided to help ensure reliable operation of the unit. Heat is removed by conduction, convection, and radiation to the surrounding environment. The example is presented in section 6.6. The power output of the module should not be allowed to exceed rated power ($V_{o_set} \times I_{o_max}$).

6.6 Power Derating

The operating case temperature range of CFDHR300-110S series is -40°C to $+100^{\circ}\text{C}$. When operating the CFDHR300-110S series, proper derating or cooling is needed. The maximum case temperature under any operating condition should not exceed 100°C .

The following curve is the de-rating curve of CFDHR300-110S series without heat sink.

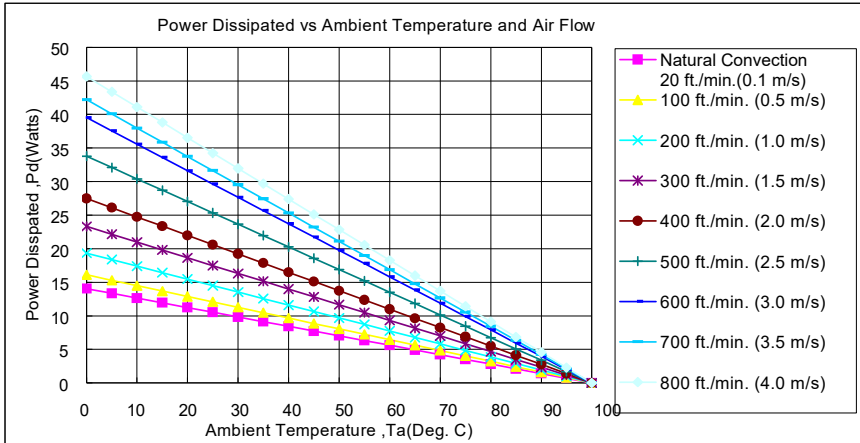

AIR FLOW RATE	TYPICAL R_{ca}
Natural Convection 20ft./min. (0.1m/s)	7.12 $^{\circ}\text{C}/\text{W}$
100 ft./min. (0.5m/s)	6.21 $^{\circ}\text{C}/\text{W}$
200 ft./min. (1.0m/s)	5.17 $^{\circ}\text{C}/\text{W}$
300 ft./min. (1.5m/s)	4.29 $^{\circ}\text{C}/\text{W}$
400 ft./min. (2.0m/s)	3.64 $^{\circ}\text{C}/\text{W}$
500 ft./min. (2.5m/s)	2.96 $^{\circ}\text{C}/\text{W}$
600 ft./min. (2.5m/s)	2.53 $^{\circ}\text{C}/\text{W}$
700 ft./min. (2.5m/s)	2.37 $^{\circ}\text{C}/\text{W}$
800 ft./min. (2.5m/s)	2.19 $^{\circ}\text{C}/\text{W}$

Example:

What is the minimum airflow necessary for a CFDHR300-110S24 operating at nominal line voltage, an output current of 12.5A, and a maximum ambient temperature of 15°C

Solution:

Given:

$$V_{in}=110V_{DC}, V_o=24V_{DC}, I_o=12.5A$$

Determine Power dissipation (P_d):

$$P_d = P_i - P_o = P_o(1-\eta)/\eta$$

$$P_d = 24V \times 12.5A \times (1-0.89)/0.89 = 37.08\text{Watts}$$

Determine airflow:

$$\text{Given: } P_d = 37.08\text{W and } T_a = 15^{\circ}\text{C}$$

Check Power Derating curve:

$$\text{Minimum airflow} = 800 \text{ ft./min.}$$

Verify:

Maximum temperature rise is

$$\Delta T = P_d \times R_{ca} = 37.08\text{W} \times 2.19 = 81.2^{\circ}\text{C.}$$

Maximum case temperature is

$$T_c = T_a + \Delta T = 96.2^{\circ}\text{C} < 100^{\circ}\text{C.}$$

Where:

The R_{ca} is thermal resistance from case to ambient environment.

T_a is ambient temperature and T_c is case temperature.

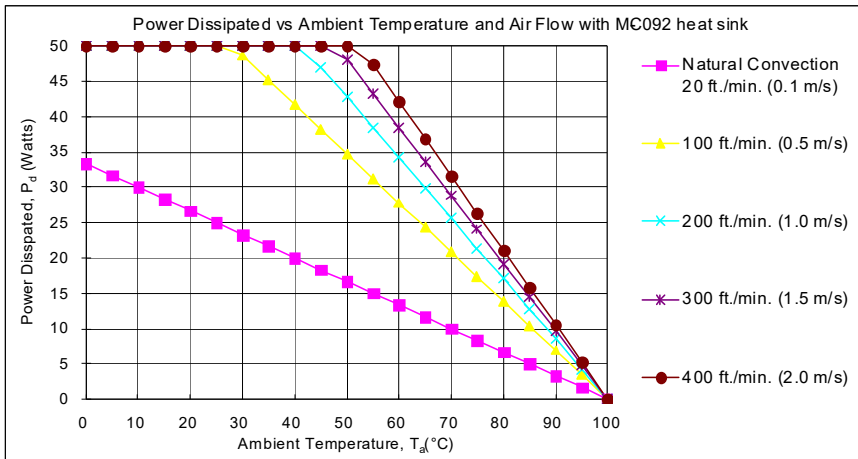

AIR FLOW RATE	TYPICAL R _{ca}
Natural convection 20ft./min. (0.1m/s)	3.00°C/W
100 ft./min. (0.5m/s)	1.44°C/W
200 ft./min. (1.0m/s)	1.17°C/W
300 ft./min. (1.5m/s)	1.04°C/W
400 ft./min. (2.0m/s)	0.95°C/W

Example (with heat sink M-C092):

What is the minimum airflow necessary for a CFDHR300-110S24 operating at nominal line voltage, an output current of 12.5A, and a maximum ambient temperature of 45°C

Solution:

Given:

$$V_{in}=110V_{DC}, V_o=24V_{DC}, I_o=12.5A$$

Determine Power dissipation (P_d):

$$P_d = P_i - P_o = P_o(1-\eta)/\eta$$

$$P_d = 24 \times 12.5 \times (1-0.89)/0.89 = 37.08 \text{ Watts}$$

Determine airflow:

$$\text{Given: } P_d=37.08W \text{ and } T_a=45^\circ C$$

Check above Power de-rating curve:

$$\text{Minimum airflow} = 100 \text{ ft./min}$$

Verify:

$$\text{Maximum temperature rise is } \Delta T = P_d \times R_{ca} = 37.08 \times 1.44 = 53.40^\circ C$$

$$\text{Maximum case temperature is } T_c = T_a + \Delta T = 98.40^\circ C < 100^\circ C$$

Where:

The R_{ca} is thermal resistance from case to ambient environment.

T_a is ambient temperature and T_c is case temperature.

6.7 Half Brick Heat Sinks:

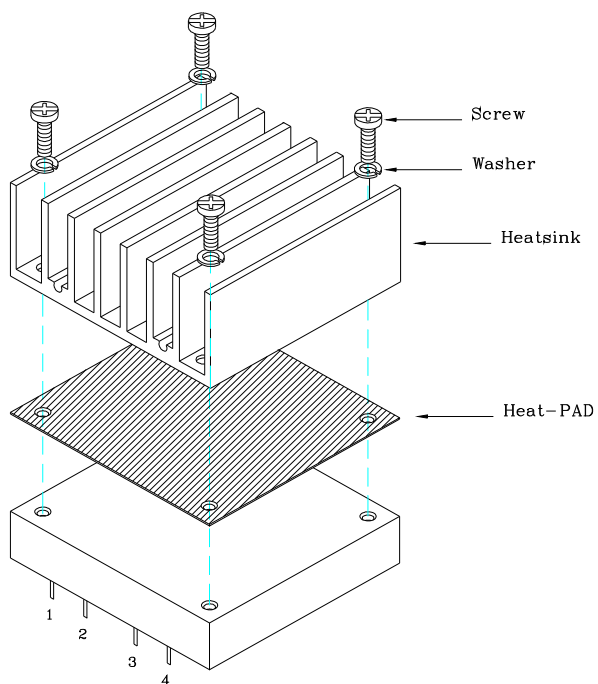

THERMAL PAD: SZ 56.9*60*0.25 mm (G6135041091)
SCREW: SMP+SW M3*8L (G75A1300322)

6.8 Efficiency VS. Load

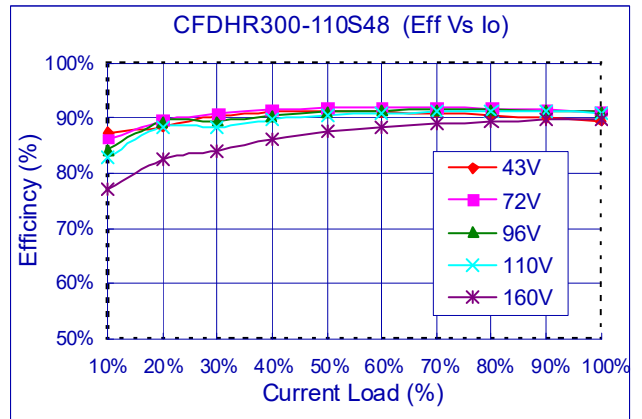
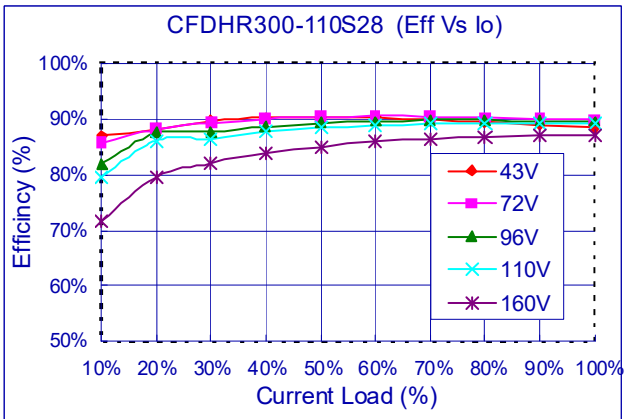
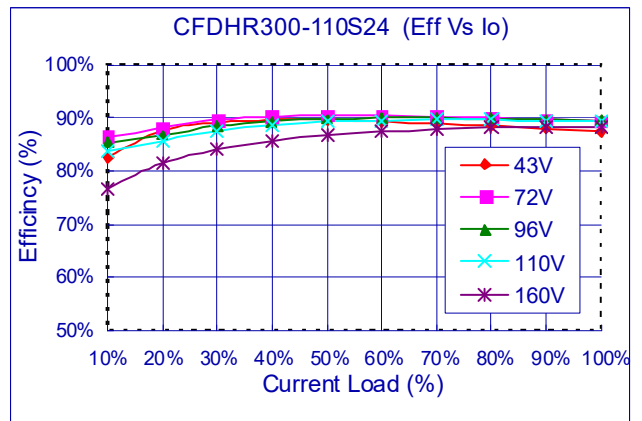
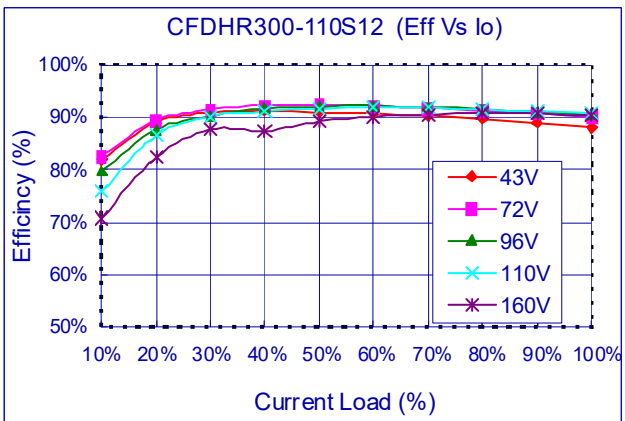
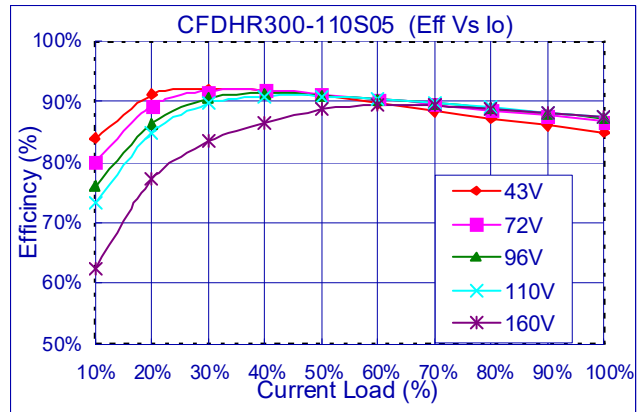
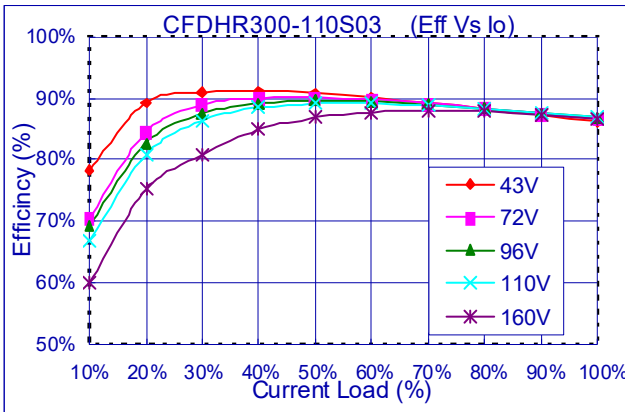

6.9 Test Set-Up

The basic test set-up to measure parameters such as efficiency and load regulation is shown below. When testing the modules under any transient conditions please ensure that the transient response of the source is sufficient to power the equipment under test. We can calculate:

- Efficiency
- Load regulation and line regulation.

The value of efficiency is defined as:

$$\eta = \frac{V_o \times I_o}{V_{in} \times I_{in}} \times 100\%$$

Where:

- V_o is output voltage,
- I_o is output current,
- V_{in} is input voltage,
- I_{in} is input current.

The value of load regulation is defined as:

$$\text{Load.reg} = \frac{V_{FL} - V_{NL}}{V_{NL}} \times 100\%$$

Where:

- V_{FL} is the output voltage at full load
- V_{NL} is the output voltage at no load

The value of line regulation is defined as:

$$\text{Line.reg} = \frac{V_{HL} - V_{LL}}{V_{LL}} \times 100\%$$

Where: V_{HL} is the output voltage of maximum input voltage at full load. V_{LL} is the output voltage of minimum input voltage at full load.

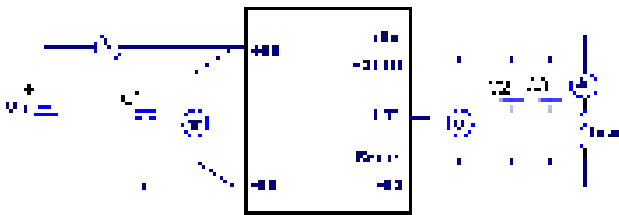

CFDHR300-110S Series Test Setup

- C1: 220uF/200V ESR<0.14Ω
- C2: 1uF/ 1210 ceramic capacitor
- C3: 10uF aluminum solid capacitor for other models.
47uF T521 KO CAP. <55mR for 5Vout

6.10 Output Voltage Adjustment

Output may be externally trimmed ($\pm 10\%$) with a fixed resistor or an external trim pot as shown (optional). Model specific formulas for calculating trim resistors are available upon request as a separate document.

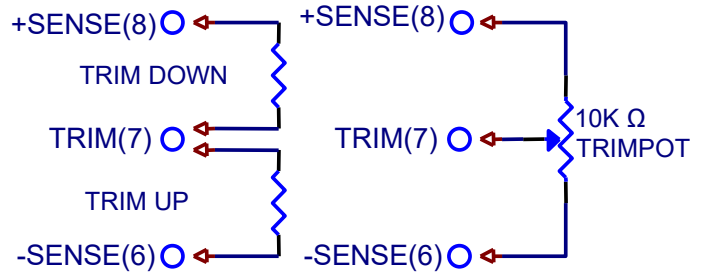

In order to trim the voltage up or down, one needs to connect the trim resistor either between the trim pin and -Sense for trim-up or between trim pin and +Sense for trim-down. The output voltage trim range is $\pm 10\%$. This is shown:

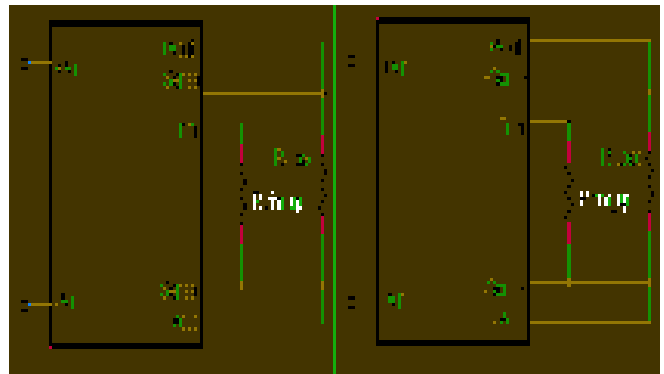

Trim-up Voltage Setup

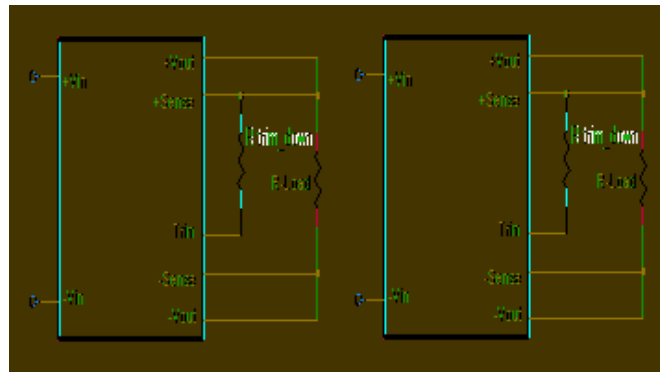

Trim-down Voltage Setup

V_{out} (V)	R1(KΩ)	R2(KΩ)	R3(KΩ)	V_r (V)	V_f (V)
3.3V	3.0	12	4.3	1.24	0.46
5V	2.32	3.3	0	2.5	0
12V	9.1	51	5.1	2.5	0.46
24V	20	100	7.5	2.5	0.46
28V	23.7	150	6.2	2.5	0.46
48V	36	270	5.1	2.5	0.46

Trim Resistor Values

The value of R_{trim_up} defined as:

For $V_o=5V$ R_{trim_up} decision:

$$R_{trim_up} = \frac{R_1 V_r}{V_o - V_{o_nom}} - R_2 \text{ (K}\Omega\text{)}$$

For others R_{trim_up} decision:

$$R_{trim_up} = \left(\frac{R_1(V_r - V_f \left(\frac{R_2}{R_2 + R_3} \right))}{V_o - V_{o_nom}} \right) - \frac{R_3 R_2}{R_2 + R_3} \text{ (K}\Omega\text{)}$$

Where:

R_{trim_up} is the external resistor in KΩ.

V_{o_nom} is the nominal output voltage.

V_o is the desired output voltage.

R₁, R₂, R₃ and V_r are internal components.

For example, to trim-up the output voltage of 12V module (CFDHR300-110S12) by 5% to 12.6V, R_{trim_up} is calculated as follows:

$$\begin{aligned} V_o - V_{o_nom} &= 12.6 - 12 = 0.6V \\ R_1 &= 9.1 \text{ K}\Omega, R_2 = 51 \text{ K}\Omega, R_3 = 5.1 \text{ K}\Omega \\ V_r &= 2.5 \text{ V}, V_f = 0.46 \text{ V} \end{aligned}$$

$$R_{trim_up} = \frac{18.944}{0.6} - 4.636 = 26.94 \text{ K}\Omega$$

The value of R_{trim_down} defined as:

$$R_{trim_down} = \frac{R_1 \times (V_o - V_r)}{V_{o_nom} - V_o} - R_2 \text{ (K}\Omega\text{)}$$

Where:

R_{trim_down} is the external resistor in KΩ.

V_{o_nom} is the nominal output voltage.

V_o is the desired output voltage.

R₁, R₂, R₃ and V_r are internal components.

For example, to trim-down the output voltage of 12V module (CFDHR300-110S12) by 5% to 11.4V, R_{trim_down} is calculated as follows:

$$R_{trim_down} = \frac{R_1 \times (V_o - V_r)}{V_{o_nom} - V_o} - R_2 \text{ (K}\Omega\text{)}$$

The typical value of R_{trim_up}

Trim up (%)	R _{trim_up} (KΩ)					
	3.3V	5V	12V	24V	28V	48V
1%	78.78	112.7	153.2	165.7	168.3	148.6
2%	37.80	54.70	74.30	79.36	81.16	71.81
3%	24.15	35.37	47.99	50.58	52.12	46.21
4%	17.32	25.70	34.83	36.19	37.60	33.40
5%	13.22	19.90	26.94	27.56	28.86	25.72
6%	10.49	16.03	21.68	21.80	23.08	20.60
7%	8.54	13.27	17.92	17.69	18.93	16.94
8%	7.08	11.20	15.10	14.61	15.82	14.20
9%	5.94	9.589	12.91	12.21	13.40	12.07
10%	5.03	8.300	11.15	10.29	11.47	10.36

The typical value of R_{trim_down}

Trim down (%)	R _{trim_down} (KΩ)					
	3.3V	5V	12V	24V	28V	48V
1%	172.3	110.4	660.3	1671	1984	3106
2%	78.64	52.38	300.1	775.8	905.5	1400
3%	47.42	33.05	180.0	477.2	545.8	831.5
4%	31.82	23.38	120.0	327.9	365.9	547.1
5%	22.45	17.58	83.98	238.3	258.0	376.5
6%	16.21	13.71	59.97	178.6	186.0	262.8
7%	11.75	10.95	42.82	136.0	134.6	181.5
8%	8.41	8.880	29.95	104.0	96.10	120.6
9%	5.81	7.269	19.95	79.07	66.12	73.17
10%	3.73	5.980	11.94	59.17	42.14	35.25

6.11 Output Remote Sensing

The CFDHR300-110S series converter has the capability to remotely sense both lines of its output. This feature moves the effective output voltage regulation point from the output of the unit to the point of connection of the remote sense pins. This feature automatically adjusts the real output voltage of the CFDHR300-110 series in order to compensate for voltage drops in distribution and maintain a regulated voltage at the point of load. The remote-sense voltage range is:

$$[(+V_{out}) - (-V_{out})] - [(+Sense) - (-Sense)] \leq 10\% \text{ of } V_{o_nominal}$$

When remote sense is in use, the sense should be connected by twisted-pair wire or shield wire. If the sensing patterns short, heavy current flows and the pattern may be damaged. Output voltage might become unstable because of impedance of wiring and load condition when length of wire is exceeding 400mm. This is shown in the schematic below.

If the remote sense feature is not to be used, the sense pins should be connected locally. The +Sense pin should be connected to the +Vout pin at the module and the -Sense pin should be connected to the -Vout pin at the module. Wire between +Sense and +Vout and between -Sense and -Vout as short as possible. Loop wiring should be avoided. The converter might become unstable by noise coming from poor wiring. This is shown in the schematic below.

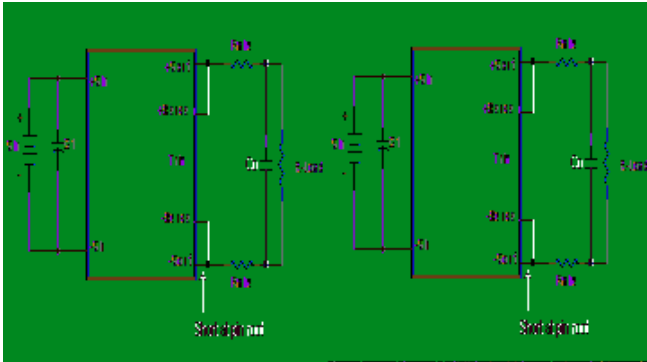

Note: Although the output voltage can be varied (increased or decreased) by both remote sense and trim, the maximum variation for the output voltage is the larger of the two values not the sum of the values. The output power delivered by the module is defined as the voltage at the output terminals multiplied by the output current. Using remote sense and trim can cause the output voltage to increase and consequently increase the power output of the module if output current remains unchanged. Always ensure that the output power of the module remains at or below the maximum rated power. Also be aware that if $V_{o,set}$ is below nominal value, $P_{out,max}$ will also decrease accordingly because $I_{o,max}$ is an absolute limit. Thus, $P_{out,max} = V_{o,set} \times I_{o,max}$ is also an absolute limit.

6.12 Output Ripple and Noise

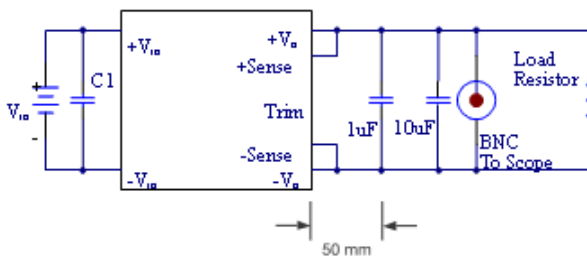

Output ripple and noise measured with 47uF T521 KO CAP. <55mR capacitor and 1uF ceramic capacitor across output for 3.3Vout & 5Vout and 10uF aluminum solid and 1uF ceramic capacitor for other models. A 20 MHz bandwidth oscilloscope is normally used for the measurement.

The conventional ground clip on an oscilloscope probe should never be used in this kind of measurement. This clip, when placed in a field of radiated high frequency energy, acts as an antenna or inductive pickup loop, creating an extraneous voltage that is not part of the output noise of the converter.



Another method is shown in below, in case of coaxial-cable/BNC is not available. The noise pickup is eliminated by pressing scope probe ground ring directly against the -Vout terminal while the tip contacts the +Vout terminal. This makes the shortest possible connection across the output terminals.

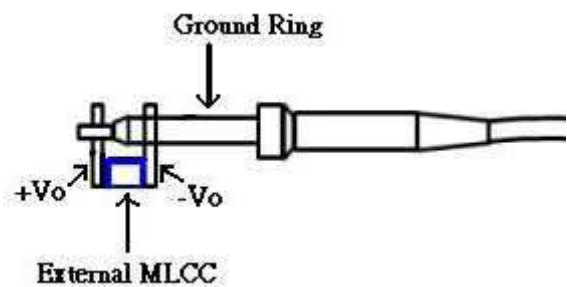

6.13 Output Capacitance

The CFDHR300-110S series converters provide unconditional stability with or without external capacitors. For good transient response, low ESR output capacitors should be located close to the point of load (<100mm). PCB design emphasizes low resistance and inductance tracks in consideration of high current applications. Output capacitors with their associated ESR values have an impact on loop stability and bandwidth. Chewins's converters are designed to work with load capacitance to see technical specifications.

6.14 Remote On/Off circuit

The converter remote On/Off circuit built-in on input side. The ground pin of input side Remote On/Off circuit is -Vin pin. Refer to 5.6 for more details. Connection examples see below.

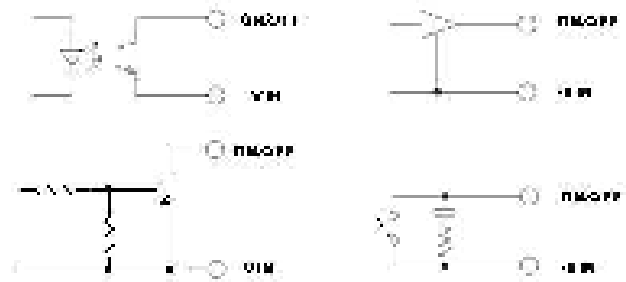

Remote On/Off Connection Example

6.15 Series operation

Series operation is possible by connecting the outputs two or more units. Connection is shown in below. The output current in series connection should be lower than the lowest rate current in each power module.

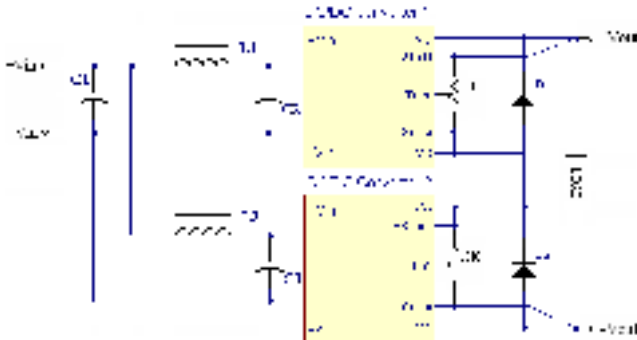

Simple Series Operation Connect Circuit

L1, L2: 1.0uH
C1, C2, C3: 220uF/200V ESR<0.140Ω

Note:

1. If the impedance of input line is high, C1,C2,C3 capacitance must be more than above. Use more than two recommended capacitor above in parallel when ambient temperature becomes lower than -20°C
2. Recommend Schottky diode (D1,D2) be connected across the output of each series connected converter, so that if one converter shuts down for any reason, then the output stage won't be thermally overstressed. Without this external diode, the output stage of the shut-down converter could carry the load current provided by the other series converters, with its MOSFETs conducting through the body diodes. The MOSFETs could then be overstressed and fail. The external diode should be capable of handling the full load current for as long as the application is expected to run with any unit shut down.

Series for ±output operation is possible by connecting the outputs two units, as shown in the schematic below.

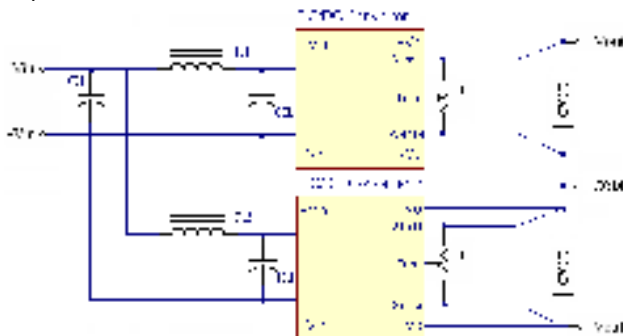

Simple ±Output Operation Connect Circuit

L1, L2: 1.0uH
C1, C2, C3: 220uF/200V ESR<0.140Ω

Note:

If the impedance of input line is high, C1, C2, C3 capacitance must be more than above. Use more than two recommended capacitor above in parallel when ambient temperature becomes lower than -20 °C

6.16 Parallel / Redundant operation

The CFDHR300-110S series parallel operation is not possible. Parallel for redundancy operation is possible by connecting the units as shown in the schematic below. The current of each converter become unbalance by a slight difference of the output voltage. Make sure that the output voltage of units of equal value and the output current from each power supply does not exceed the rate current. Suggest use an external potentiometer to adjust output voltage from each power supply.

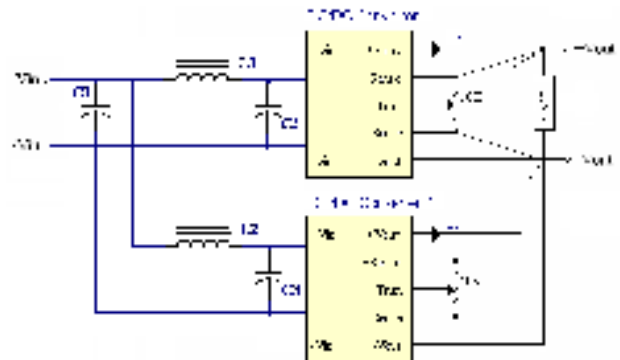

Simple Redundant Operation Connect Circuit

L1, L2: 1.0uH
C1, C2, C3: 220uF/200V ESR<0.140Ω

Note:

If the impedance of input line is high, C1, C2, C3 capacitance must be more than above. Use more than two recommended capacitor above in parallel when ambient temperature becomes lower than -20 °C

6.17 Hold up Time

Hold up time is defined as the duration of time that DC/DC converter output will remain active following a loss of input power. To meet power supply interruptions, an external circuit is required, shown below.

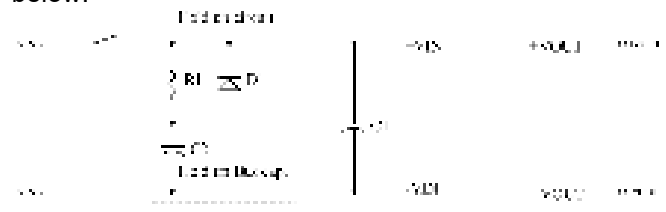

D1: 200V/10A
R1: 100Ω/10W
C1: 220uF/200V ESR<0.140Ω

	C2	72Vin	96Vin	110Vin
Hold up time for 10ms		2700uF	1000uF	700uF
Hold up time for 30ms		8000uF	3400uF	2400uF
Hold up time for 10ms(Vo: 3.3V)		1600uF	600uF	400uF
Hold up time for 30ms(Vo: 3.3V)		5100uF	2200uF	1500uF

7. Safety/EMC

7.1 EMC Considerations

EMI Test standard: EN50121-3-2:2015 Conducted/Radiated Emission
Test Condition: Input Voltage: 110V_{DC}, Output Load: Full Load

(1) EMI meet EN50121-3-2:2015:

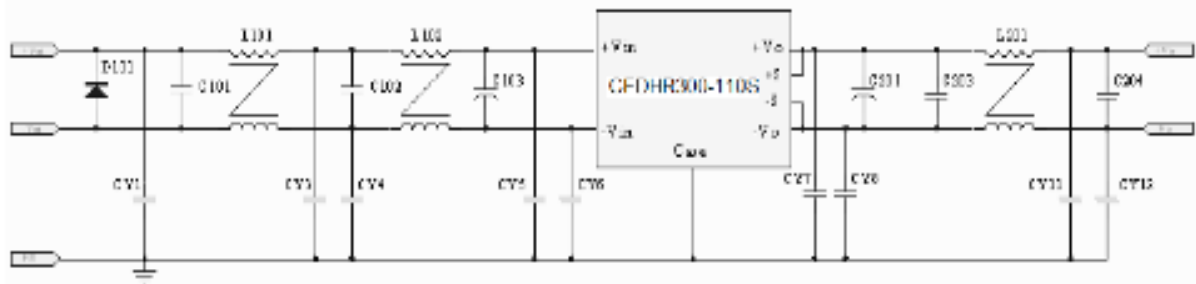

Figure1 Connection circuit for EMI testing

Model Number

	CFDHR300-110S03	CFDHR300-110S05	CFDHR300-110S12	CFDHR300-110S24	CFDHR300-110S28	CFDHR300-110S48
C101	1uF/250V X7R	1uF/250V X7R	1uF/250V X7R	1uF/250V X7R	1uF/250V X7R	1uF/250V X7R
C102	1812	1812	1812	1812	1812	1812
C103	220uF/200V Aluminum cap. YXF series	220uF/200V Aluminum cap. YXF series	220uF/200V Aluminum cap. YXF series	220uF/200V Aluminum cap. YXF series	220uF/200V Aluminum cap. YXF series	220uF/200V Aluminum cap. YXF series
C201	47uF/20V Polymer tantalum cap.	47uF/20V Polymer tantalum cap.	10uF/50V X5R 1210	10uF/50V X5R 1210	10uF/50V X5R 1210	22uF/100V Aluminum solid cap.
C203	1uF/100V X7R	1uF/100V X7R	1uF/100V X7R	1uF/100V X7R	1uF/100V X7R	1uF/100V X7R
C204	1206	1206	1206	1206	1206	1206
CY1	NC	NC	NC	1000pF/Y2	NC	NC
CY3	220pF/Y2	220pF/Y2	220pF/Y2	220pF/Y2	220pF/Y2	220pF/Y2
CY4	4700pF/Y2	4700pF/Y2	4700pF/Y2	4700pF/Y2	4700pF/Y2	4700pF/Y2
CY5	2200pF/Y2	2200pF/Y2	2200pF/Y2	2200pF/Y2	2200pF/Y2	2200pF/Y2
CY6	1000pF/Y2	1000pF/Y2	1000pF/Y2	1000pF/Y2	1000pF/Y2	1000pF/Y2
CY7	10000pF/Y2	NC	NC	NC	NC	NC
CY8						
CY11	10000pF/Y2	10000pF/Y2	10000pF/Y2	10000pF/Y2	10000pF/Y2	10000pF/Y2
CY12						
D101	1.5KE180A Littelfuse	1.5KE180A Littelfuse	1.5KE180A Littelfuse	1.5KE180A Littelfuse	1.5KE180A Littelfuse	1.5KE180A Littelfuse
L101	ACME A10 T25*15*15C	ACME A10 T25*15*15C	ACME A10 T25*15*15C	ACME A10 T25*15*15C	ACME A10 T25*15*15C	ACME A10 T25*15*15C
L102	3.5mH, ϕ 1.0mm*1/16T	3.5mH, ϕ 1.0mm*1/16T	3.5mH, ϕ 1.0mm*1/16T	3.5mH, ϕ 1.0mm*1/16T	3.5mH, ϕ 1.0mm*1/16T	3.5mH, ϕ 1.0mm*1/16T
L201	FERROXCUBE T29/19/15-3E6	FERROXCUBE T29/19/15-3E6	VAKOS R10K T22*16*6.5C	VAKOS R12K T18*12*6C	VAKOS R12K T18*12*6C	VAKOS R12K T18*12*6C
	0.17mH, ϕ 1.0mm*4/4T	0.17mH, ϕ 1.0mm*4/4T	0.28mH, ϕ 1.0mm*2/7T	0.28mH, ϕ 1.0mm*1/7T	0.28mH, ϕ 1.0mm*1/7T	0.28mH, ϕ 1.0mm*1/7T

Note:

C103 is RUBYCON YXF series aluminum capacitors or equivalent, CYxx is MURATA Y2 capacitor or equivalent.

Conducted Emission(Input):

CFDHR300-110S05

Line

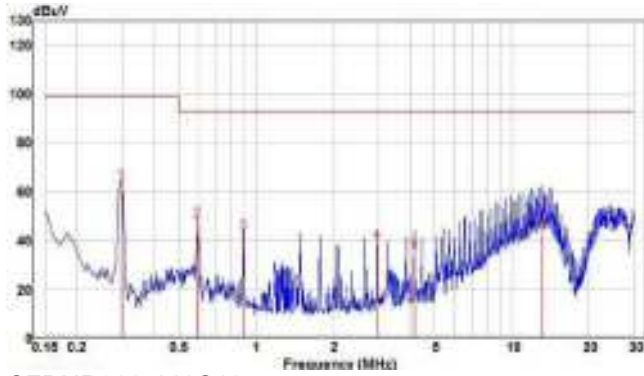

Neutral

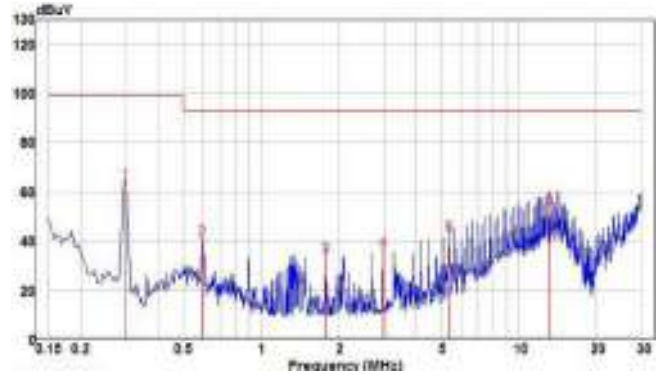

CFDHR300-110S12

Line

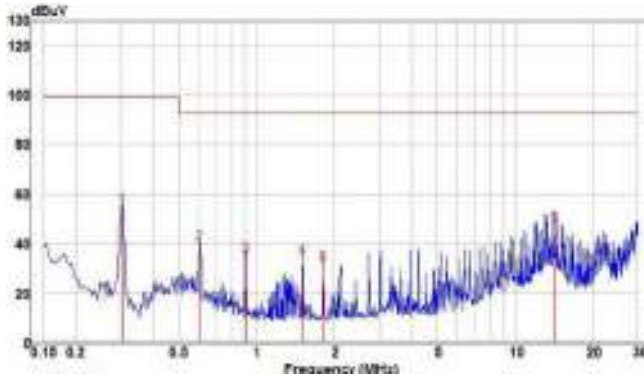

Neutral

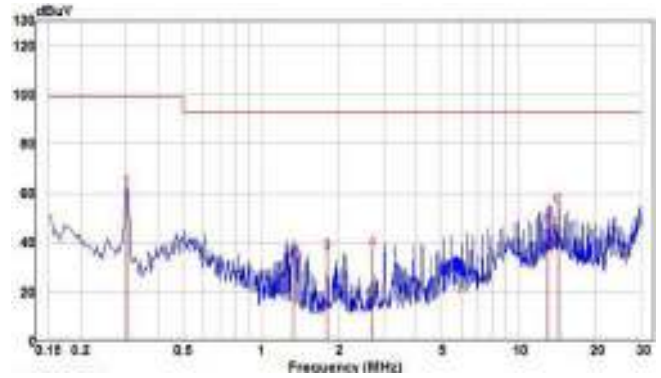

CFDHR300-110S24

Line

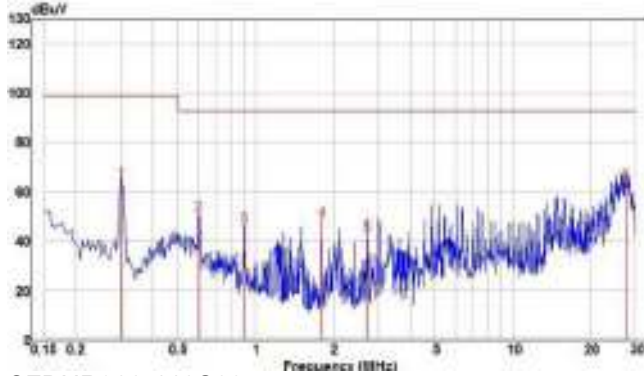

Neutral

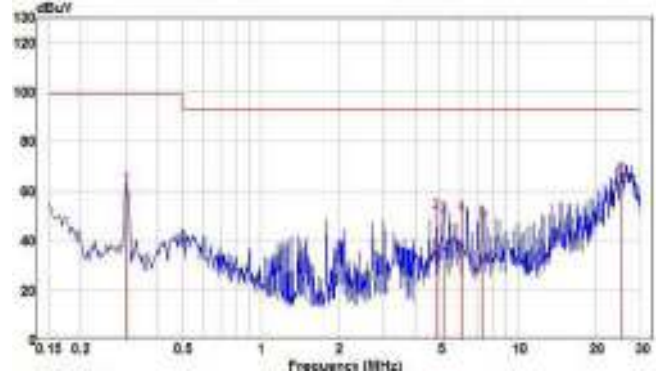

CFDHR300-110S28

Line

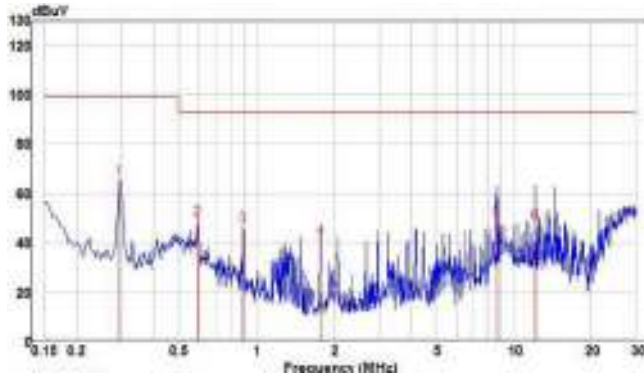

Neutral

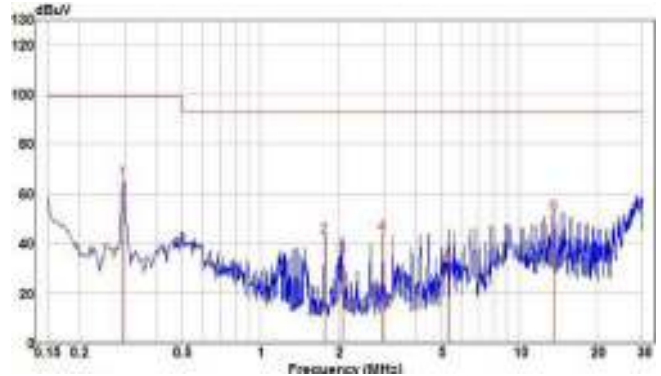

CFDHR300-110S48

Line

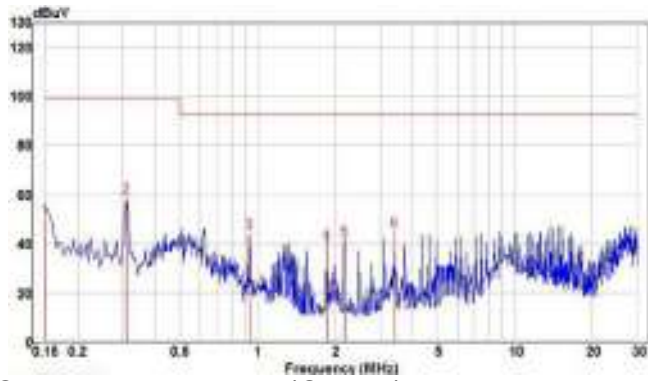

Neutral

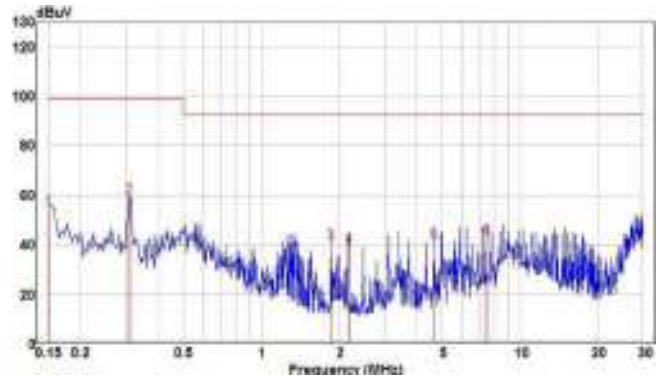

Conducted Emission(Output):

CFDHR300-110S05

Positive

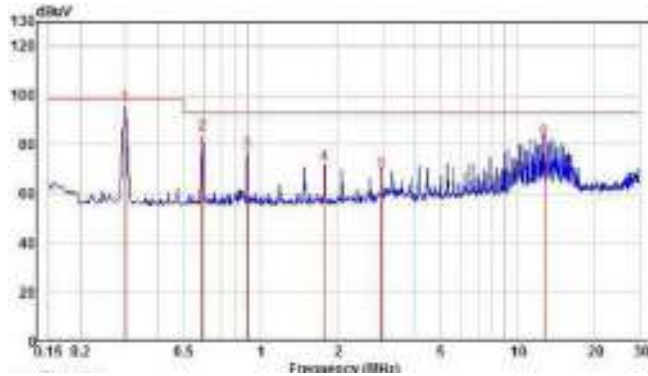

Negative

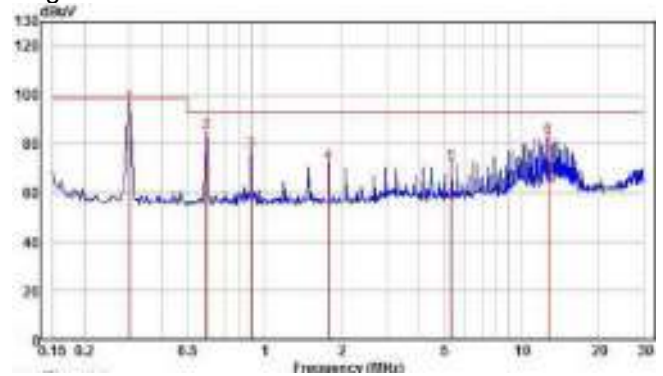

CFDHR300-110S12

Positive

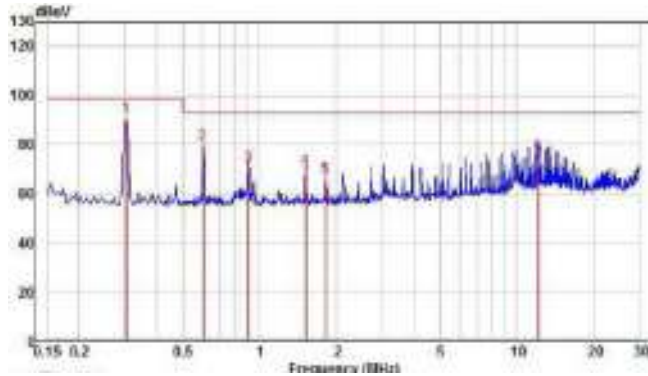

Negative

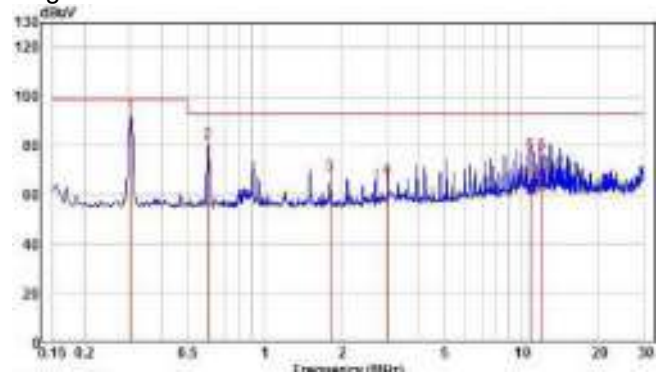

CFDHR300-110S24

Positive

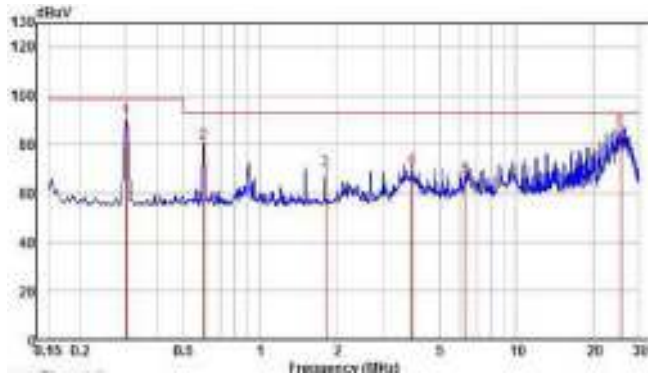

Negative

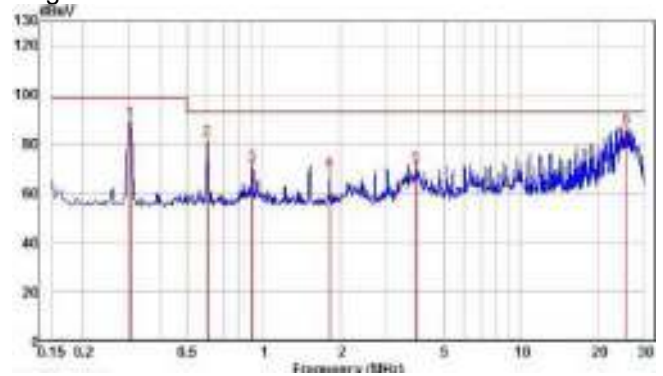

CFDHR300-110S28

Positive

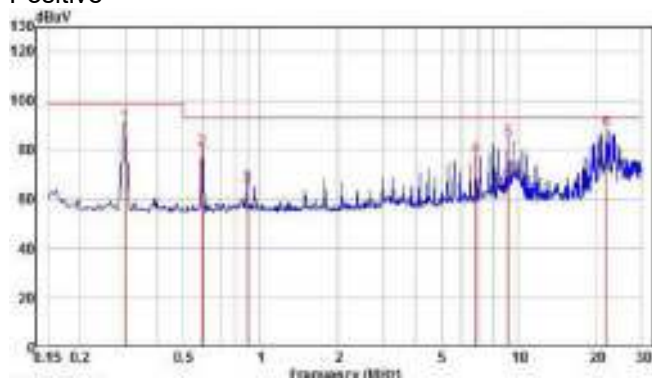

Negative

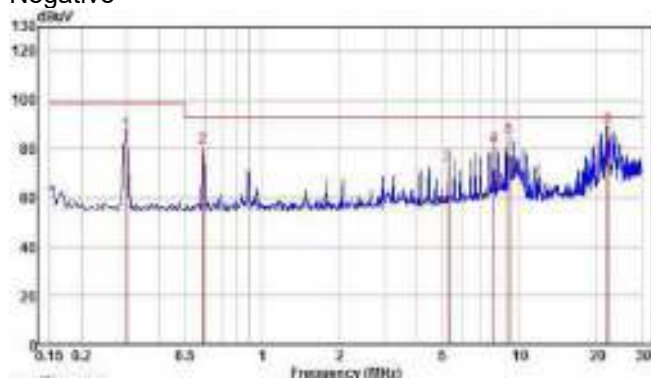

CFDHR300-110S48

Positive

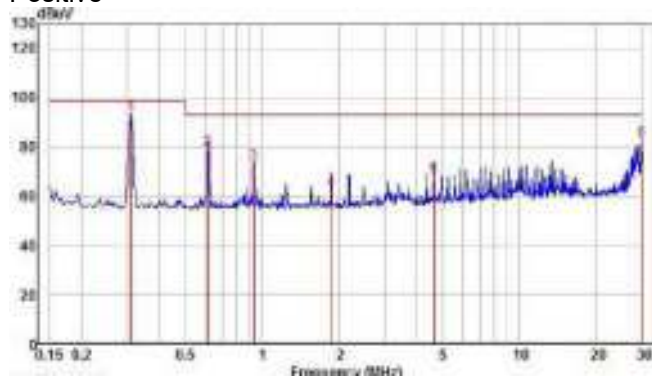

Negative

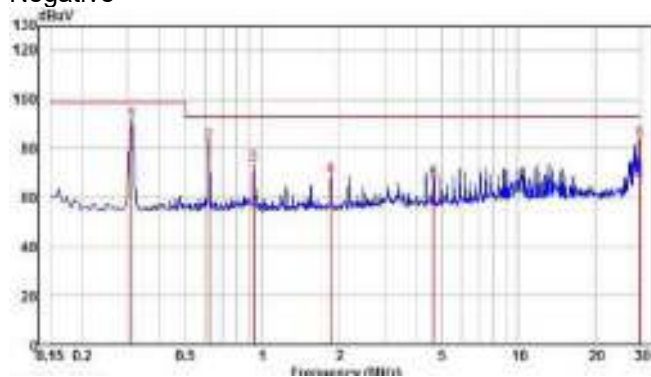

Radiated Emission:

CFDHR300-110S05

Vertical

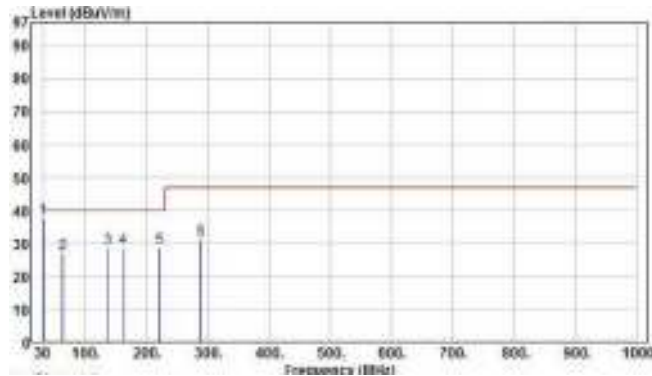

Horizontal

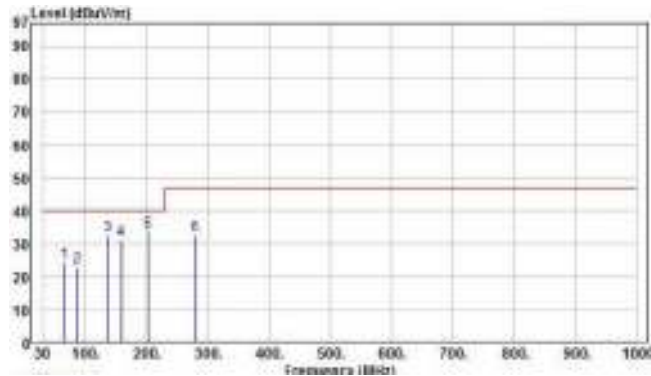

CFDHR300-110S12

Vertical

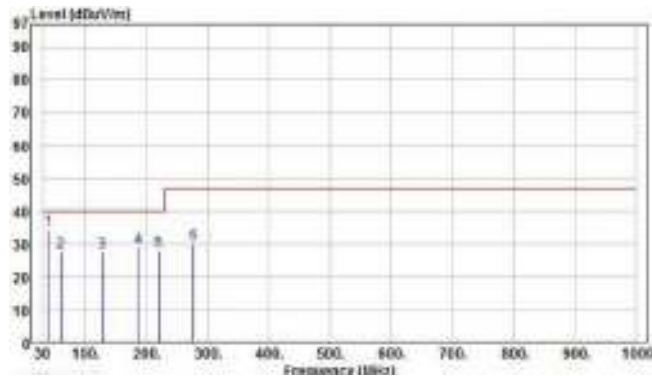

Horizontal

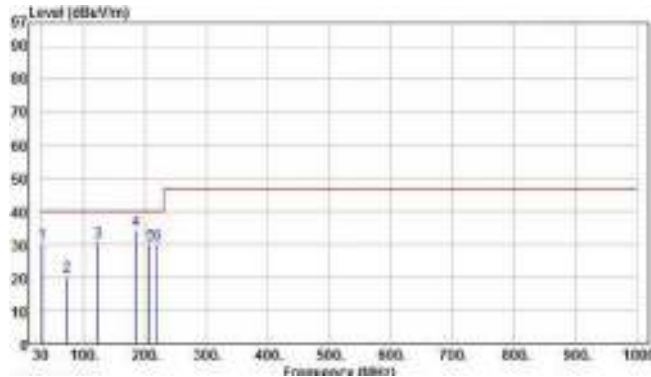

CFDHR300-110S24

Vertical

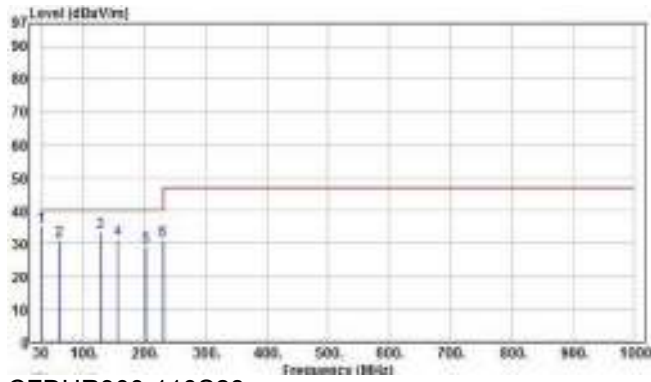

Horizontal

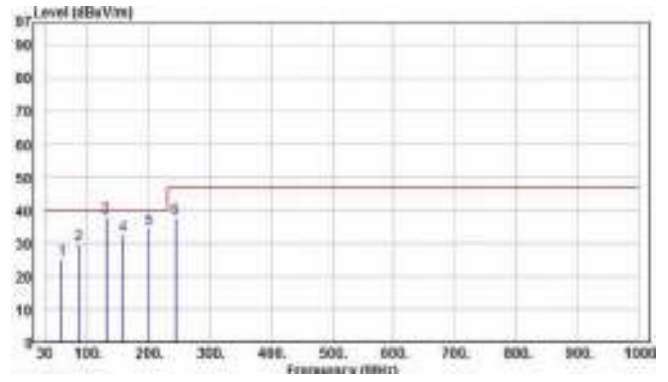

CFDHR300-110S28

Vertical

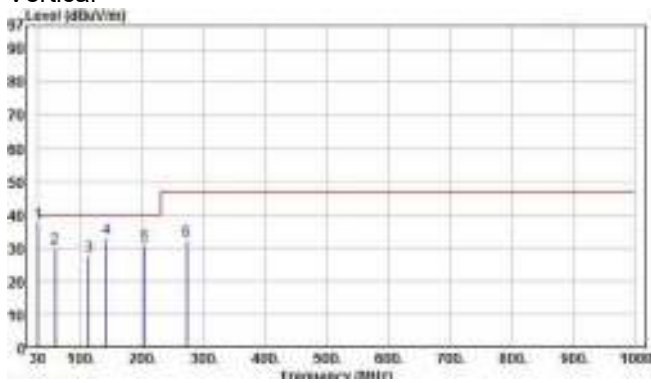

Horizontal

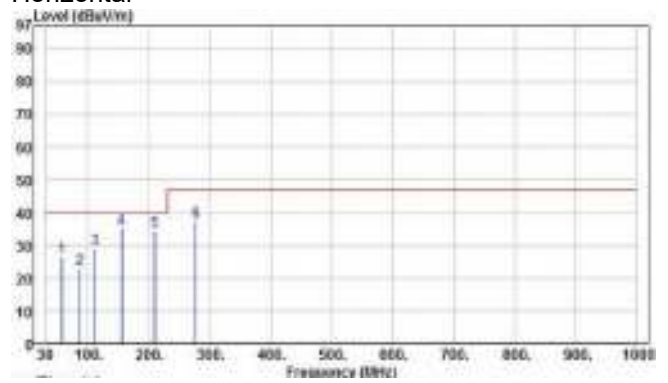

CFDHR300-110S48

Vertical

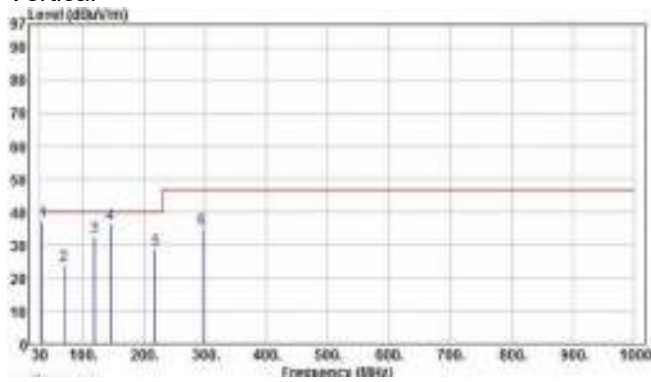

Horizontal

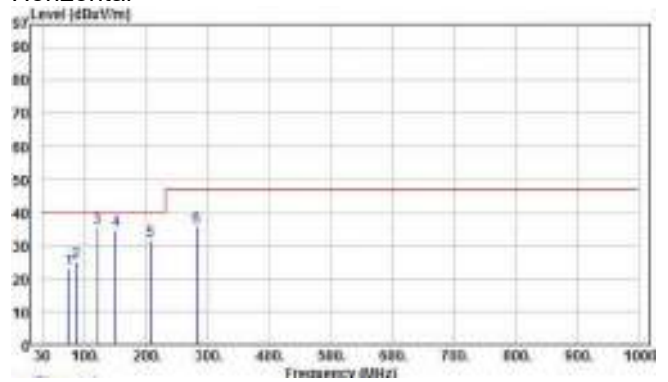

7.3 Suggested Configuration for RIA12 Surge Test

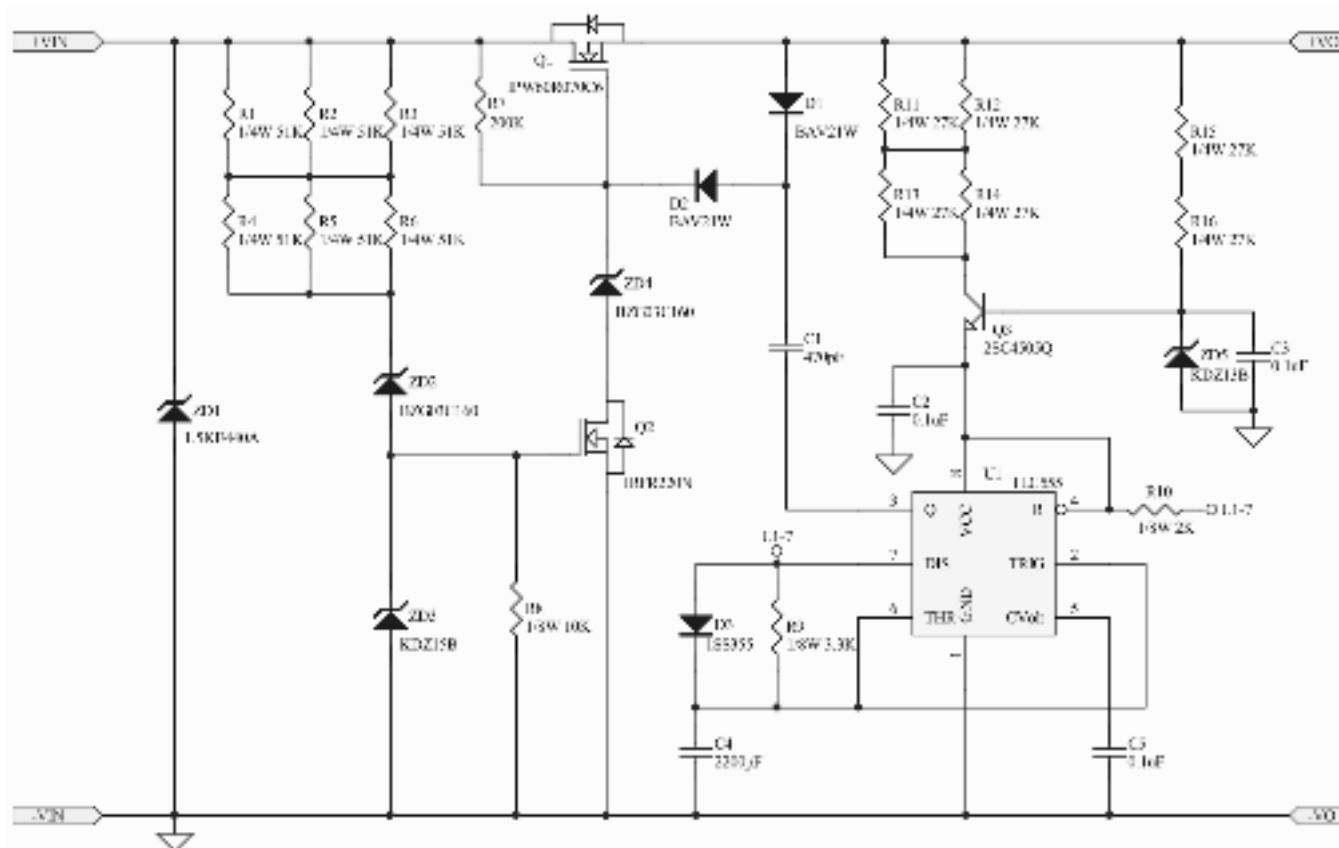

Note: Q1 suggest use Infineon IPW60R070C6 or equivalent, and provide good heat dissipation conditions.

8. Part Number

Format:CFDHR300-110S03/05/12/24/28/48

Parameter	Series	Nominal Input Voltage	Number of Outputs	Output Voltage	Remote On/Off Logic	Mounting Inserts
Symbol	CFDHR300	II	O	XX	L	Y (Option)
Value	CFDHR300	110:110Volts	S:Single	03:3.3Volts 05:5Volts 12:12Volts 24:24Volts 28:28Volts 48:48Volts	None:Positive N:Negative	Clear Mounting C:Insert (3.2mmDIA.)

9. Mechanical Specifications

9.1 Mechanical Outline Diagrams

All Dimensions In mm[Inches]

Tolerances Inches:X.XX=±0.02,X.XXX=±0.01

Millimeters:X.X=±0.5,X.XX=±0.25

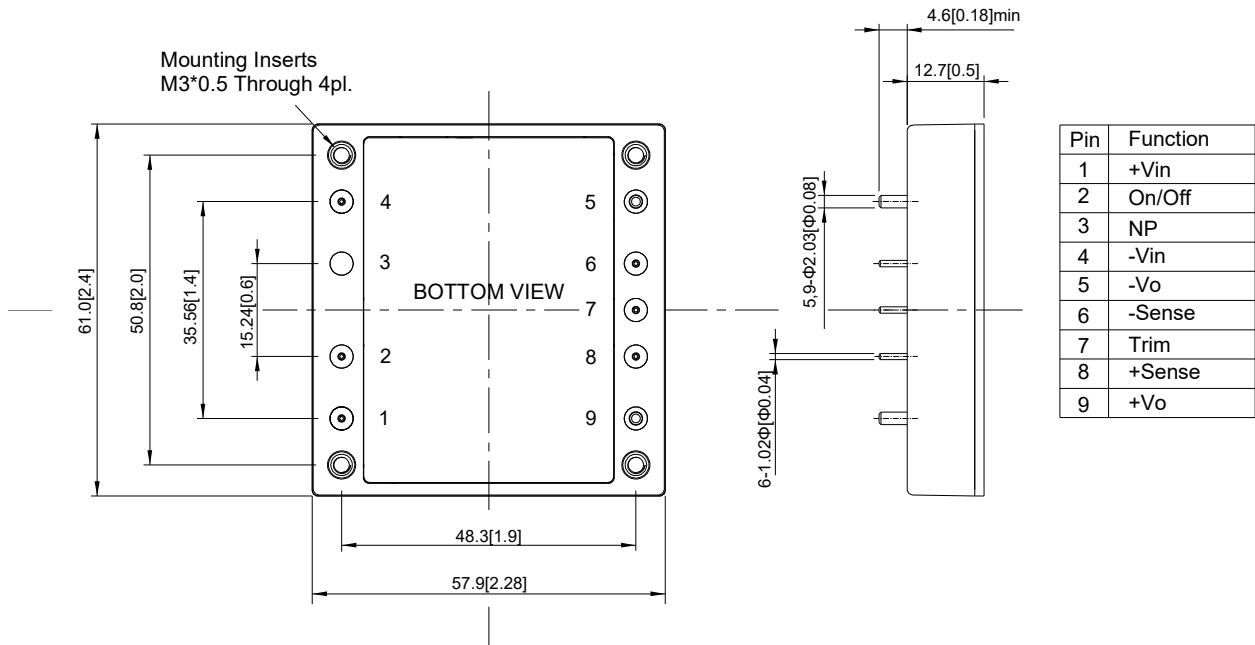

CHEWINS Beijing Science & Technology Co.,Ltd.

Address:No.25,torch South Street,Zhuozhou Development Zone,Hebei Province,people's Republic of China
Tel:86-10-68817997 Mobile phone:15901068673 E-mail:sales@chewins.net www.chewins.net